

Tefal®

VERSALIO DELUXE

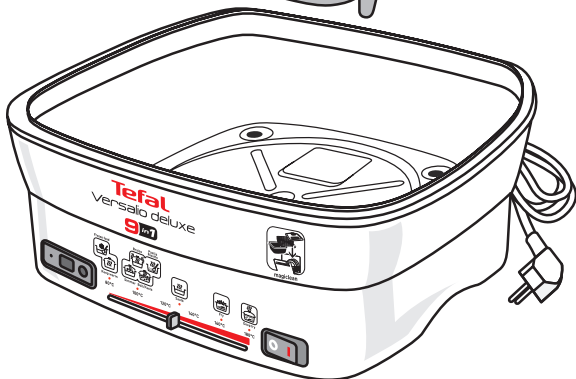

www.tefal.com

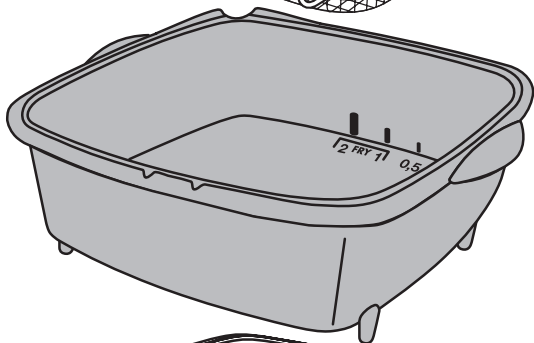
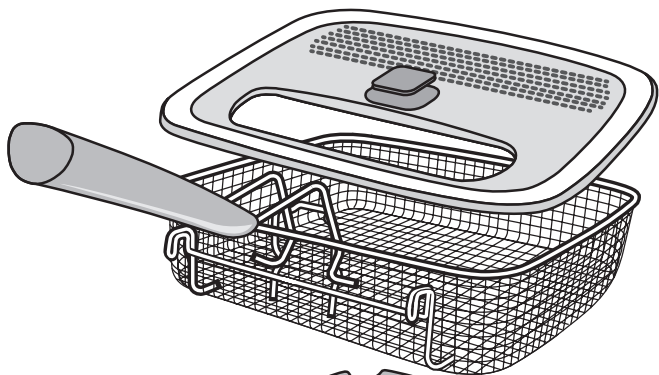

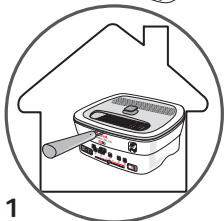

1

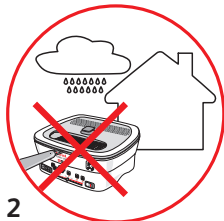

2

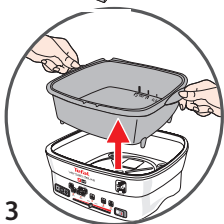
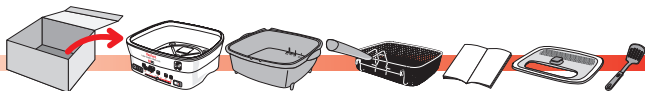

3

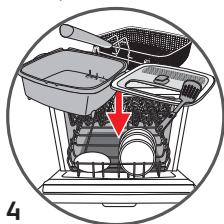

4



5

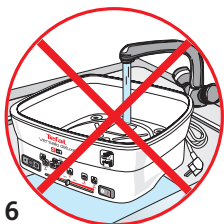

6



7



8

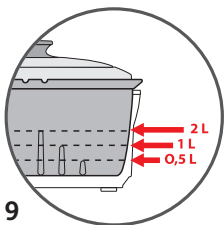

9



10

2



Fry



Deep fry



Fry

0,5 L



Deep fry

2 L

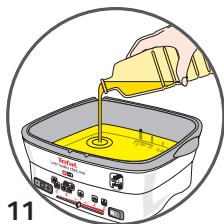

11

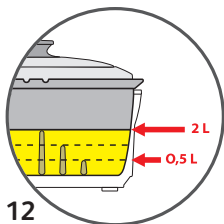

12

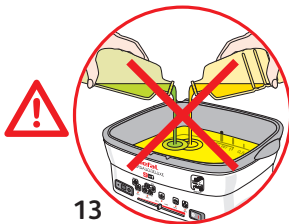

13



Fry

< 0,5 L



Deep fry

1 L → 2 L

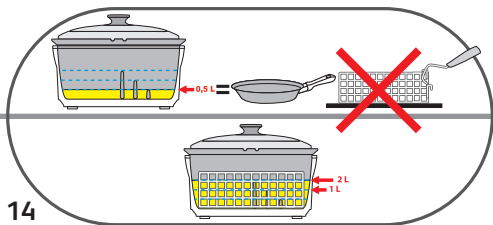

14

3



Deep fry



Max 1000 g

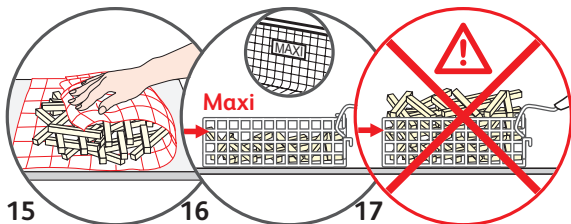

15

16

17



Max 750 g

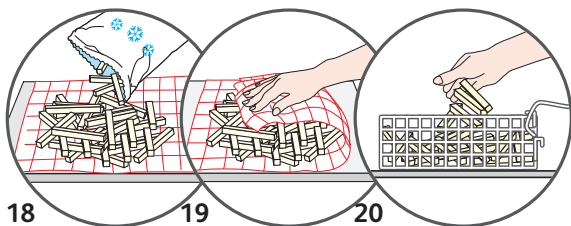

18

19

20

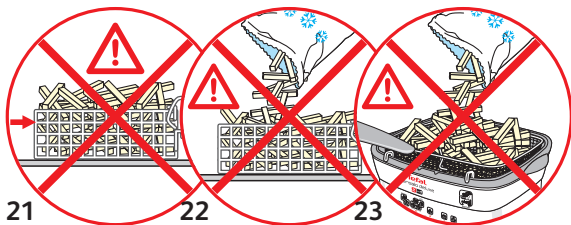

21

22

23



Deep fry

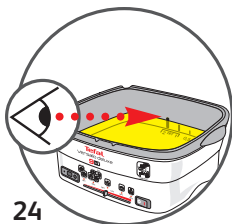

24



25

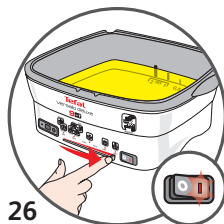

26

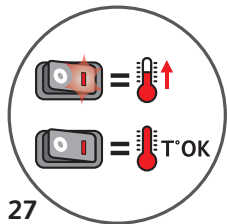

27

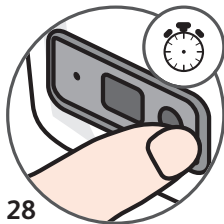

28

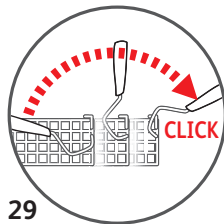

29

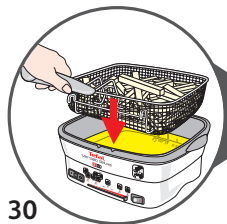

30

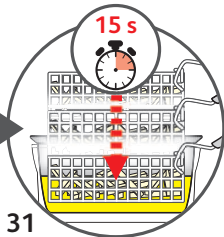

31

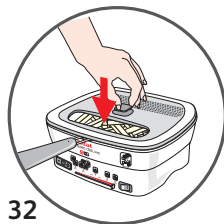

32



33



34

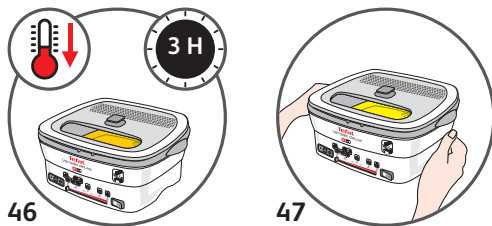
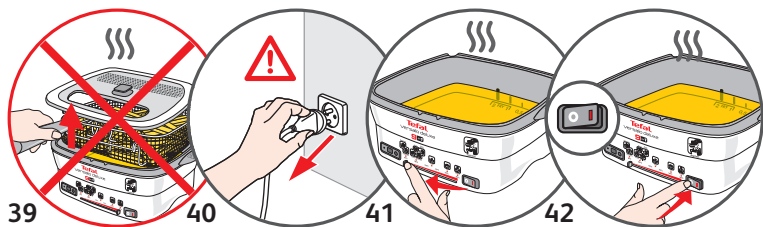
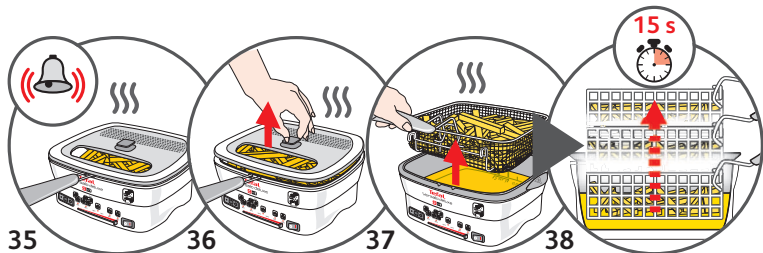







5 Deep fry / 180 °C



Deep fry







 2 L maxi				
	1000 g	15-16 min	4	
	550 g	10-11 min		
	750 g	13-14 min		
	400 g	7-8 min		



6 Fry / 160 °C



Fry

 0,5 L maxi			
	15 min	4	
	30 min	6	



7

Sauté

Sauté / 130 °C

x1	10 min	4

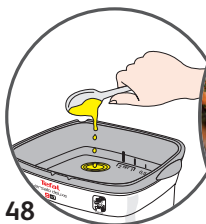
**8**

Simmer

Simmer / 100 °C

30 min	4

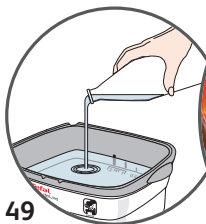

9**Boil/Pasta**

Boil/Pasta

	
30 min	4

**10****Rice/Risotto/Paella**

Paella/Risotto

	
15 min	4



11**Braise**

Braise

40 min	4



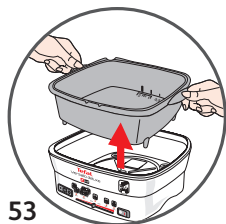
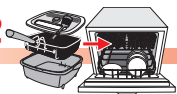

53

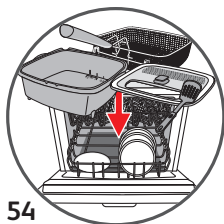

54

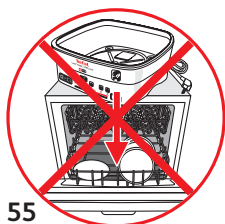

55

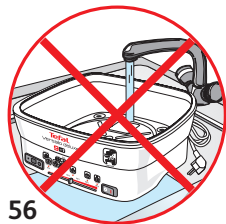

56

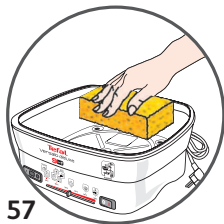

57



58

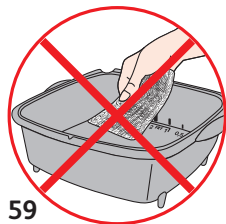

59

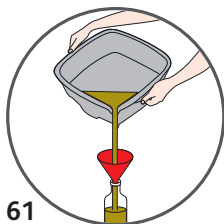
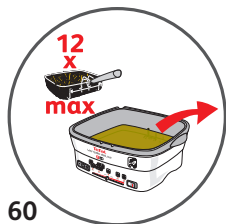

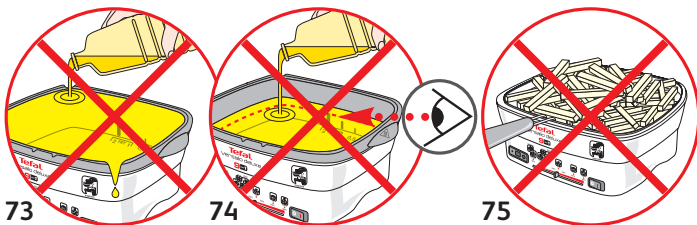
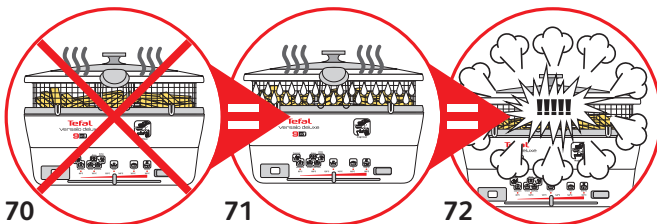
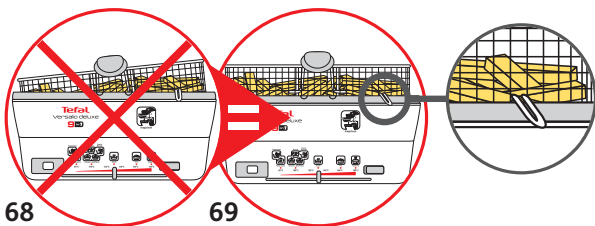
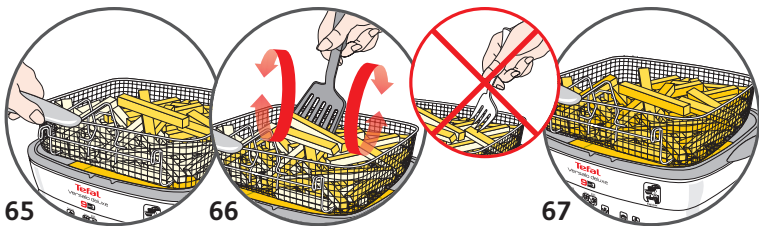



76

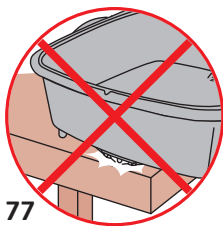



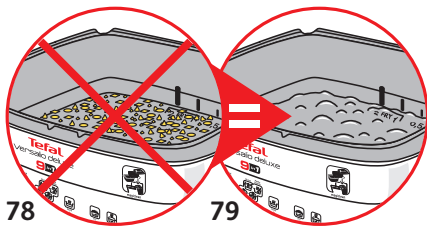

77











78

79

INTERNATIONAL GUARANTEE : COUNTRY LIST

			
الجزائر ALGERIA	CIJA 9 rue Puvis de Chavannes - Saint Euquene Oran	(0)41 28 18 53	1 an 1 year
ARGENTINA	GRUPE SEB ARGENTINA S.A. Billinghurst 1833 3° - C1425DTK Capital Federal - Buenos Aires	0800-122-2732	2 años 2 years
ՀԱՅԱՍՏԱՆ ARMENIA	ՓԲԸ Փրոպոլս ԱՆԲ-Վ, 125171 Մոսկվա, Լենինգրադյան խնամի, 16A, շին.3	(010) 55-76-07	2 տարի/ 2 years
AUSTRALIA	GRUPE SEB AUSTRALIA PO Box 7535, Silverwater NSW 2128	02 97487944	1 year
ÖSTERREICH AUSTRIA	SEB ÖSTERREICH GmbH Campus 21 - Businesspark Wien Süd Liebermannstr. A02 702 - 2345 Brunn am Gebirge	01 8903476	2 Jahre 2 years
BELGIQUE BELGIE BELGIUM	GRUPE SEB BELGIUM SA NV 25 avenue de l'Espérance - ZI 6220 Fleurus	070 23 31 59	2 ans 2 years
БЕЛАРУСЬ BELARUS	ЗАО «Група СЕБ-Восток», 125171, Москва, Ленинградское - шоссе, д. 16А, стр. 3	017 2239290	2 года 2 years
BOSNA I HERCEGOVINA	SEB Développement Predstavništvo u BiH - Vrazova 8/II 71000 Sarajevo	Info-linija za potrošače 033 551 220	2 godine 2 years
BRASIL BRAZIL	SEB COMERCIAL DE PRODUTOS DOMÉSTICOS LTDA Rua Venâncio Aires, 433/437/447, Pompéia, São Paulo/SP	0800-119933	1 ano 1 year
БЪЛГАРИЯ BULGARIA	ГРУП СЕБ БЪЛГАРИЯ ЕООД Ул. Борово 52 Г, ет. 1, офис 1, 1680 София	0700 10 330	2 години 2 years
CANADA	GRUPE SEB CANADA 345 Passmore Avenue Toronto, ON M1V 3N8	800-418-3325	1 an 1 year
CHILE	GRUPE SEB CHILE Comercial Ltda Av. Providencia, 2331, piso 5, oficina 501 Santiago	12300 209207	2 años 2 years
COLOMBIA	GRUPE SEB COLOMBIA Apartado Aereo 172, Kilometro 1 Via Zipaquira - Cajica Cundinamarca	18000919288	2 años 2 years
HRVATSKA CROATIA	SEB Développement S.A.S. Vodnjanska 26 10000 Zagreb	01 30 15 294	2 godine 2 years
ČESKÁ REPUBLIK CZECH REPUBLIC	GRUPE SEB ČR spol. s r. o. Jankovcova 1569/2c 170 00 Praha 7	731 010 111	2 roky 2 years
DANMARK	GRUPE SEB NORDIC AS Tempovej 27 2750 Ballerup	44 663 155	2 år 2 years
DEUTSCHLAND GERMANY	GRUPE SEB DEUTSCHLAND GmbH / KRUPS GmbH Herrnrainweg 5 63067 Offenbach	0212 387 400	2 Jahre 2 years
EESTI ESTONIA	GRUPE SEB POLSKA SP Z O.O. ul. Bukowińska 22b 02-703 Warszawa	5 800 3777	2 aastat 2 years
SUOMI FINLAND	Group SEB Finland Kutojantie 7 02630 Espoo	09 622 94 20	2 Vuotta 2 years

			
FRANCE Incluant uniquement Guadeloupe, Martinique, Réunion, Saint-Martin	GRUPE SEB FRANCE Service Consommateur Tefal BP 15 - 69131 ECULLY CEDEX	09 74 50 47 74	1 an 1 year
ΕΛΛΑΔΑ GREECE	SEB GROUPE ΕΛΛΑΔΟΣ Α.Ε. Οδός Καβαλιεράτου 7 Τ.Κ. 145 64 Ν. Κηφισιά	2106371251	2 χρόνια 2 years
香港 HONG KONG	SEB ASIA Ltd. Room 903, 9/F, South Block, Skyway House 3 Sham Mong Road, Tai Kok Tsui, Kowloon - Hong-Kong	852 8130 8998	1 year
MAGYARORSZÁG HUNGARY	GRUPE SEB CENTRAL-EUROPE Kft. Táviró köz - 4 2040 Budaörs	06 1 801 8434	2 év 2 years
INDONESIA	Groupe SEB Indonesia (Representative office) Sudirman Plaza, Plaza Marein 8th Floor JL Jendral Sudirman Kav 76-78, Jakarta 12910, Indonesia	+62 21 5793 6881	1 year
ITALIA ITALY	GRUPE SEB ITALIA S.p.A. Via Montefeltro, 4 - 20156 Milano	199207354	2 anni 2 years
JAPAN	GRUPE SEB JAPAN Co. Ltd. 1F Takanawa Muse Building, 3-14-13, Higashi Gotanda, Shinagawa-Ku, Tokyo 141-0022	0570-077772	1 year
ҚАЗАҚСТАН KAZAKHSTAN	ЖАҚ «Группа СЕБ- Востоку» 125171, Мәскеу, Ленинградское шоссеі, 16А, 3 үйі	727 378 39 39	2 жыл 2 years
KOREA	(유)그룹 세브 코리아 서울시 종로구 서린동 88 서린빌딩 3층 - 110-790	1588-1588	1 year
LATVJA LATVIA	GRUPE SEB POLSKA Sp. z o.o. ul. Bukowińska 22b 02-703 Warszawa	6 716 2007	2 gadi 2 years
LIETUVA LITHUANIA	GRUPE SEB POLSKA Sp. z o.o. ul. Bukowińska 22b 02-703 Warszawa	6 470 8888	2 metai 2 years
LUXEMBOURG	GRUPE SEB BELGIUM SANV 25 avenue de l'Espérance - ZI 6220 Fleurus	0032 70 23 31 59	2 ans 2 years
MACEDONIA	Groupe SEB Bulgaria EOOD Office 1, floor 1, 52G Borovo St., 1680 Sofia - Bulgaria ГРУП СЕБ БЪЛГАРИЯ ДООЕЛ Ул. Борово 52 Г, сн. 1, офис 1, 1680 София - България	(0)2 20 50 022	2 годин 2years
MALAYSIA	GRUPE SEB MALAYSIA SDN. BHD Unit No. 402-403, Level 4, Uptown 2, No. 2, Jalan SS21/37, Damansara Uptown, 47400, Petaling Jaya, Selangor D.E Malaysia	65 6550 8900	1 year
MEXICO	G.S.E.B. MEXICANA, S.A. DE C.V. Goldsmith 38 Desp. 401, Col. Polanco - Delegacion Miguel Hildalgo 11 560 Mexico D.F.	(01800) 112 8325	1 años 1 year
MOLDOVA	ТОВ «Груп СЕБ Україна» 02121, Харківське шосе, 201-203, 3 поверх, Київ, Україна	(22) 929249	2 ani 2 years
NEDERLAND The Netherlands	GRUPE SEB NEDERLAND BV Generatorstraat 6 - 3903 LJ Veenendaal	0318 58 24 24	2 jaar 2 years
NEW ZEALAND	GRUPE SEB NEW ZEALAND Unit E, Building 3, 195 Main Highway, Ellerslie, Auckland	0800 700 711	1 year
NORGE NORWAY	GRUPE SEB NORDIC AS Tempovej 27 2750 Ballerup DANMARK	815 09 567	2 år 2 years
PERU	Groupe SEB Perú Av. Camino Real N° 111 of. 805 B San Isidro - Lima - Perú	441 4455	1 años 1 year

			
POLSKA POLAND	GRUPE SEB POLSKA Sp. z o.o ul. Bukowińska 22b 02-703 Warszawa	0 801 300 421 koszt jak za połączenie lokalne	2 lata 2 years
PORTUGAL	GRUPE SEB IBERICA SA Urb. da Matinha - Rua Projectada à Rua 3 Bloco1 - 3º B/D 1950 - 327 Lisboa	808 284 735	2 anos 2 years
REPUBLIC OF IRELAND	GRUPE SEB IRELAND Unit B3 Aerodrome Business Park, College Road, Rathcoole, Co. Dublin	01 677 4003	1 year
ROMÂNIA ROMANIA	GRUPE SEB ROMÂNIA Str. Daniel Constantin nr. 8 - 010632 Bucureşti	0 21 316 87 84	2 ani 2 years
РОССИЯ RUSSIA	ЗАО «Группа СЕБ-Восток», 119180 Москва, 125171, Москва, Ленинградское шоссе, д. 16А, стр. 3	495 213 32 30	2 года 2 years
SRBIJA SERBIA	SEB Developpement Đorđa Stanojevića 11b 11070 Novi Beograd	060 0 732 000	2 godine 2 years
SINGAPORE	GRUPE SEB SINGAPORE Pty Ltd. 59 Jalan Pemimpin, #04-01/02 L&Y Building Singapore 577218	65 6550 8900	1 year
SLOVENSKO SLOVAKIA	GRUPE SEB SLOVENSKO s.r.o. Rybničná 40 - 831 07 Bratislava	233 595 224	2 roky 2 years
SLOVENIJA SLOVENIA	SEB d.o.o Gregorčičeva ulica 6 - 2000 MARIBOR	02 234 94 90	2 leti 2 years
ESPAÑA SPAIN	GRUPE SEB IBÉRICA S.A. C/Almogàvers, 119-123, Complejo Ecurban 08018 Barcelona	902 31 24 00	2 años 2 years
SVERIGE SWEDEN	TEFAL SVERIGE SUBSIDIARY OF GROUP SEB NORDIC Truckvägen 14 A, 194 52 Upplands Väsby	08 594 213 30	2 år 2 years
SUISSE / SCHWEIZ SWITZERLAND	GRUPE SEB SCHWEIZ GmbH Thurgauerstrasse 105 8152 Glattbrugg	044 837 18 40	2 ans 2 Jahre 2 years
TAIWAN	SEB ASIA Ltd. Taiwan Branch 4F., No. 37 Dexing W. Rd., Shilin Dist., Taipei City 11158, Taiwan (R.O.C.)	886-2-2833 3716	1 year
THAILAND	GRUPE SEB THAILAND 2034/66 Italthai Tower, 14th Floor, n° 14-02, New Phetchburi Road, Bangkapi, Huaykwang, Bangkok, 10320	662 351 8911	2 years
TÜRKIYE TURKEY	GRUPE SEB ISTANBUL AS Beybi Giz Plaza Dereboyu Cad. - Meydan Sok. No: 28 K.12 Maslak	216 444 40 50	2 YIL 2 years
U.S.A.	GRUPE SEB USA 2121 Eden Road - Millville, NJ 08332	800-395-8325	1 year
УКРАЇНА UKRAINE	ТОВ «Груп СЕБ Україна» 02121, Харківське шосе, 201-203, 3 поверх, Київ, Україна	044 492 06 59	2 роки 2 years
UNITED KINGDOM	GRUPE SEB UK LTD Riverside House, Riverside Walk Windsor, Berkshire, SL4 1NA	0845 602 1454	1 year
VENEZUELA	GRUPE SEB VENEZUELA Av Eugenio Mendoza, Centro Letonia, Torre ING Bank, Piso 15, Ofc 155 - Urb. La Castellana, Caracas	0800-7268724	2 años
VIETNAM	Vietnam Fan Joint Stock Company 25 Nguyen Thi Nho Str, Ward 9, Tan Binh Dist, HCM city	+84-8 38644037 +84-8 38645830	1 year

TEFAL / T-FAL INTERNACIONAL GARANTEE

Date of purchase: / Date d'achat / Fecha de compra / Data da compra / Data d'acquisto / Kaufdatum / Aankoopdatum / Købsdato / Inköpsdatum / Kjøpsdato / Ostopäivä / Data zakupu / Data vânzării / [sigijimo data/ Ostukuupäev / Datum nakupa / Sorozatszám / Dátum nákupu / Pirkuma datums / Datum Kupovine / Datum kupnje / Data cumpărării / Datum nákupu / Tarikh pembelian / Tanggal pembelian / Ngày mua hàng / Satin alma tarihi / Дата прџдажи / Дата на закупуване / Датум на купување / Сатылган мерзімі / Ημερομηνία αγοράς / Ὤμερομηνία ἀγορᾶς / วันทีซื้อ / 購買日期 / 購入日 / 구입일자 / تاريخ الشراء / خرید تاريخ

Product reference: / Référence du produit / Referencia del producto / Referência do produto / tipo de prodotto / Typnummer des Gerätes / Artikelnummer van het apparaat / Referencenummer / Produktreferens / Artikelnummer / Tuotenumero / referencja produktu / Model / Gaminio numeris / Toote viitenumber / Tip aparata / Vásárlás kelte / Typ výrobku / Produkta atsauces numurs / Model proizvoda / Oznaka proizvoda / Cod produs / Produk rujukan / Referensi produk / Mã sản phẩm / Ürün kodu / Мпдель / Мпдель / Мпдел на уреда / Мпдени / Κωδικός προϊόντος / Ὤνηξη / รุ่นผลิตภัณฑ์ / 產品模型 / 製品レファレンス番 / 제품명 / مرجع کامل محصول / مرجع المنتج الكامل

Retailer name & address: / Nom et adresse du vendeur / Nombre y dirección del minorista / Nome e endereço do revendedor / Nome e indirizzo delnegozzio / Name und Anschrift des Händlers / Naam en adres van de dealer / Forhandler navn & adresse / Återförsäljarens namn och adress / Forhandler navn og adresse / Jälleennyjään nimi ja osoite / nazwa i adres sprzedawcy / Numele și adresa vânzătorului / Parduotuvės pavadinimas ir adresas / Müüja kauplus ja aadress / Naziv in naslov trgovine / Tipusszám / Názov a adresa predajcu / Veikala nosaukums un adrese / Naziv i adresa maloprodaje / Naziv i adresa prodavca / Naziv i adresa prodajnog mjesta / Nume și adresă vânzător / Název a adresa prodejce / Nama dan alamat peruncit / Nama Toko Penjual dan alamat / Tên và địa chỉ cửa hàng bán/ Satici firmanın adı ve adresi / Название и адрес прџдавца / Назва i адреса прџдавця / Търговски пбект / Назив и адреса на прџдавницата / Сатушының аты және мекен-жайы / Επωνυμία και διεύθυνση καταζήτηματος / Ὤμερομηνία ἀγορᾶς / วันทีซื้อของทาง/ รานทีซื้อ / 零售商店的名和地址/販売店の名前、住所/소매점 이름과 주소 / نام و آدرس خرده فروش / اسم وعنوان بائع التجزئة

Distributor stamp Cachet distributeur / Sello del distribuidor / Carimbo do revendedor / Timbro del negozio / Händlerstempel / Stempel van de dealer / Forhandler stempel / Återförsäljarens stämpel / Forhandler stempel / Jälleennyjään leima / pieczęć sprzedawcy / Ştampila vânzătorului / Antspaudas / Tempel / Žig trgovine / Eladó neve, címe/ Razítko predajcu / Zimogs / Pečat maloprodaje/ Pečat prodavca / Pečat prodajnog mjesta / Ştampila vânzătorului/ Razítko prodejce/ Cap peruncit / Cap dari Toko Penjual / Cửa hàng bán đóng dấu/ Satici Firmasının Kaşesi / Печать прџдавца / Печатка прџдавця / Печат на търговския пбект / Печат на прџдавницата / Сатушының мөрі / Σθραγίδα καταζήτηματος / Ὤμερομηνία ἀγορᾶς / วันทีซื้อของทาง/ รานทีซื้อ / 零售商店的蓋印 / 販売店印 / 소매점 직인 / فروش مهر خرده / ختم بائع التجزئة

