

ISABEL BROCANTE KAST

SCHRANK - ARMOIRE - CABINET



KL

ZL

BL

KV

FL

PL

PD-L

AK

KF

ZR

KR

TP

FR

LP

LP

PD-R

LP

DL

OB

SL

PG

PR

| Qty | Code | Thickness | Length | Width |
|-----|------|-----------|--------|-------|
| 1 | AK | 3 | 1727 | 1056 |
| 1 | BL | 18 | 932 | 68 |
| 1 | DL | 20 | 1036 | 32 |
| 1 | FL | 18 | 1700 | 68 |
| 1 | FR | 18 | 1700 | 68 |
| 1 | KF | 467 | 1174 | 58 |
| 1 | KL | 15 | 414 | 100 |
| 1 | KR | 15 | 414 | 100 |
| 1 | KV | 15 | 1098 | 100 |
| 3 | LP | 15 | 1038 | 390 |
| 1 | OB | 15 | 1064 | 408 |
| 1 | PD-L | 463 | 1595 | 20 |
| 1 | PD-R | 463 | 1595 | 20 |
| 1 | PG | 18 | 1100 | 160 |
| 1 | PL | 18 | 412 | 160 |
| 1 | PR | 18 | 412 | 160 |
| 1 | SL | 18 | 1064 | 125 |
| 1 | TP | 15 | 1038 | 390 |
| 1 | ZL | 15 | 1700 | 396 |
| 1 | ZR | 15 | 1700 | 396 |

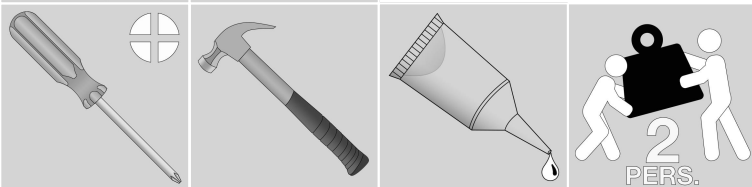

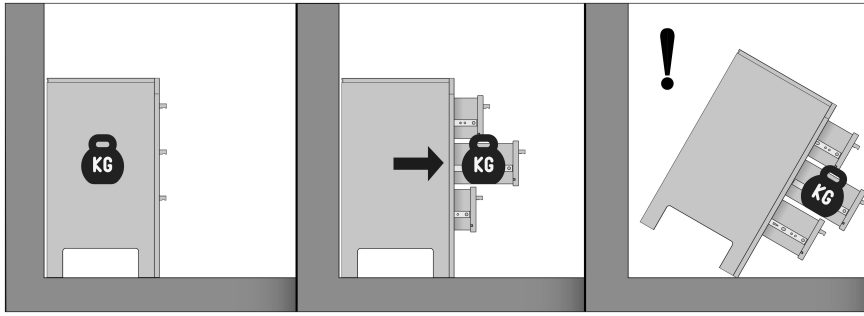

Nederlands

WAARSCHUWING.

Voorkom dat dit meubel omvalt. Meubels die omvallen kunnen ernstig of levensbedreigend letsel veroorzaken. Het meegeleverde kantelbeslag dient daarom **BESLIST** te worden gebruikt om het meubel te bevestigen aan de muur.

Sta niet toe dat kinderen klimmen op lades, deuren of planken.
Plaats zware voorwerpen altijd onderin.
Zet zware voorwerpen nooit op het meubel.

Norsk

ADVARSEL.

Unngå at dette møbelet faller. Møbler som faller kan forårsake alvorlige eller livstruende skader. Det medleverte beslaget skal derfor **ABSOLUTT** brukes for å feste møbelet til veggen.

Ikke tillat at barn klatrer på skuffer, dører eller planker.
Plasser tunge objekter alltid nederst.
Sett aldri tunge objekter på møbelet.

Deutsch

WARNHINWEIS.

Verhindern Sie, dass dieses Möbelstück umstürzt. Möbel, die umfallen, können schwere oder lebensbedrohliche Verletzungen verursachen. Zur Befestigung des Möbelstücks an der Wand sollte daher **UNBEDINGT** die mitgelieferte Kippsicherung verwendet werden.

Erlauben Sie Kindern nicht, auf Schubladen, Türen oder Regale zu klettern.
Stellen Sie schwere Gegenstände nur unten in das Möbelstück.
Stellen Sie niemals schwere Gegenstände auf das Möbelstück.

Français

ATTENTION.

Évitez que le meuble ne bascule. Les meubles qui basculent peuvent être à l'origine de blessures graves ou mortelles. La fixation anti-basculement fournie avec le meuble doit **OBLIGATOIREMENT** être utilisée pour fixer celui-ci au mur.

Ne laissez pas les enfants grimper sur les tiroirs, portes ou étagères.
Placez toujours les objets lourds dans le bas du meuble.
Ne placez jamais les objets lourds sur le meuble.

English

CAUTION.

Prevent this furniture from falling over. Falling furniture could cause severe or life-threatening injuries. Therefore, the included tip-over restraint **HAS** to be used to secure the furniture to the wall.

Do not allow children to climb on the drawers, doors or shelves.
Always place heavy objects at the bottom.
Never place heavy objects on top of the furniture.

Svenska

VARNING.

Förhindra att denna möbel välter. Möbler som välter kan orsaka allvarliga eller livshotande skador. Det medföljande tippskyddet **MÅSTE** därför användas för att förankra möbelen i väggen.

Låt inte barn klättra på lådor, dörrar eller hyllor.
Placera alltid tunga föremål längst ned.
Ställ aldrig tunga föremål på möbelen.

Polski

UWAGA.

Zabezpiecz meble przed przewróceniem. Przewrócenie się mebli może spowodować poważne lub śmiertelne obrażenia ciała. Dlatego załączone ograniczniki przechyłu **ZDECYDOWANIE** powinny zostać wykorzystane do przymocowania mebla do ściany.











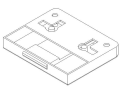

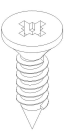

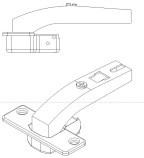
Nie pozwalaj dzieciom wspinać się na szuflady, drzwiczki lub półki.
Zawsze umieszczaj ciężkie przedmioty w dolnej części.
Nigdy nie stawiaj na meblu ciężkich przedmiotów.

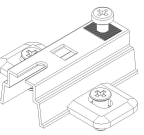
Español

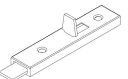
ADVERTENCIA.

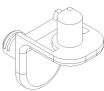
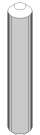
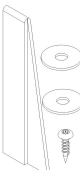
Evite que este mueble se caiga. Los muebles que se caen pueden ocasionar lesiones graves o potencialmente mortales. Por lo tanto, el herraje abatible suministrado debe utilizarse **SIN LUGAR A DUDAS** para fijar el mueble a la pared.

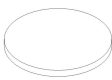
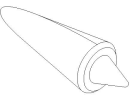
No permita que los niños se suban a los cajones, las puertas o los estantes.
Los objetos pesados siempre deben colocarse en la parte inferior.
Nunca coloque objetos pesados sobre el mueble.

| | | | | | | | |
|----|--------------|------------|---|----|----------|----------|---|
| 39 | Ø15mm | AC000102 |  | 1 | 30mm | AC000383 |  |
| 39 | 24mm | AC000103 |  | 1 | 517/46 | AC000385 |  |
| 12 | 4x16mm | AC000204 |  | 1 | Ø15mm | AC000386 |  |
| 8 | 3.5x35mm | AC000219 |  | 6 | Ø35 STOL | AC000433 |  |
| 7 | 4x.25mm | AC000229 |  | 6 | 2MM | AC000448 |  |
| 10 | 3x15 | AC000275 |  | 2 | | AC000514 |  |
| 50 | Ø1.4x25mm | AC000316 |  | 22 | 8x35mm | AC000601 |  |
| 12 | Ø5MM | AC000349 |  | 4 | 8x50mm | AC000602 |  |
| 1 | Safety Strip | AC000356 |  | 4 | 6x35mm | AC000604 |  |
| 18 | Ø14mm | AC000369-* |  | 1 | Glue | AC000607 |  |
| 1 | 17x12mm | AC000382 |  | | | | |

1

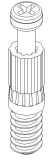
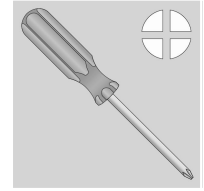
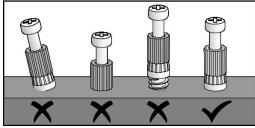

3x

AC000103

ZL

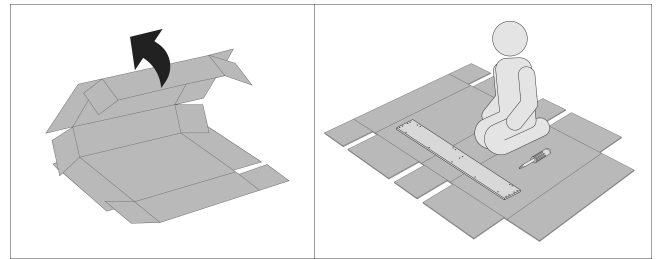

2

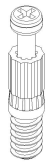
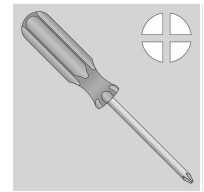
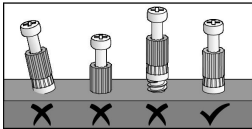

3x

AC000103

ZR

3



AC000601



6x

TP

AC000601

4

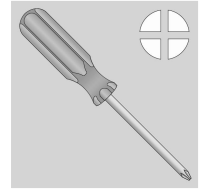

AC000102



6x

ZR

A

TP

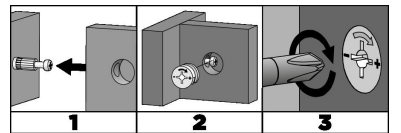

ZL

AC000102

A

5

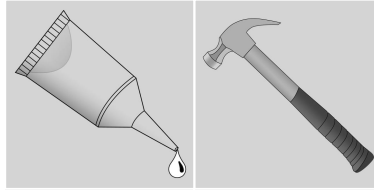
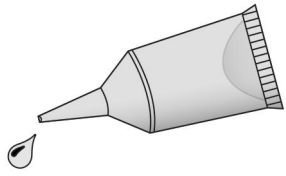

AC000607

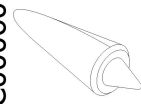

1x

AC000602



4x

BL

AC000602

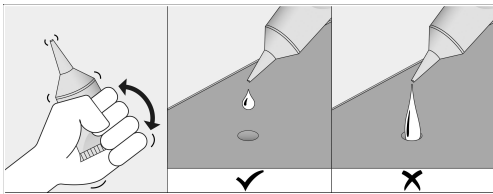

6

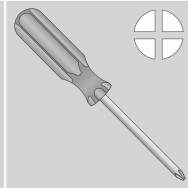

AC000604



2x

AC000448

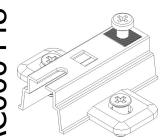

3x

AC000103



3x

AC000103

AC000448

B

FR

B

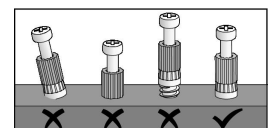

AC000604

7

7

AC000448

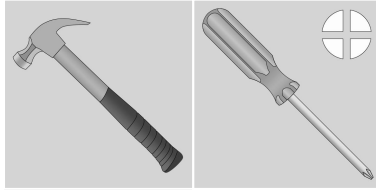

AC000604

AC000103



2x

AC000448

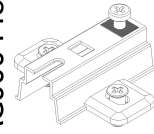

3x

AC000103

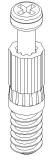

3x

C

C

FL



AC000604

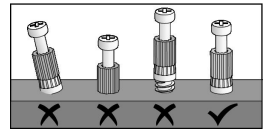

8

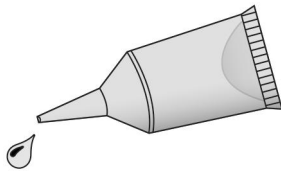

D

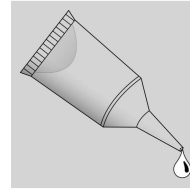

AC000607

1x

D

FR

BL

FL

9

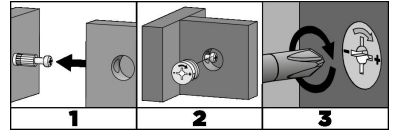
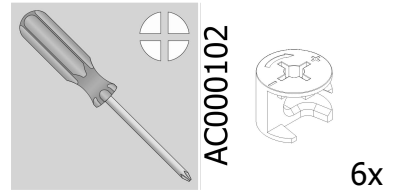

BL

FL

FR

AC000102

ZL

ZR

10

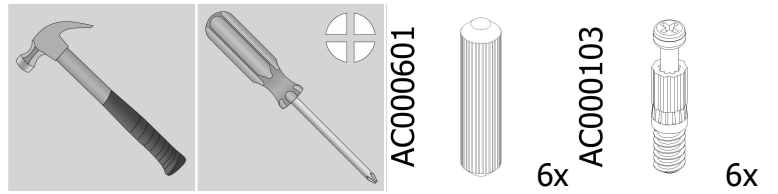

AC000103

AC000601



OB

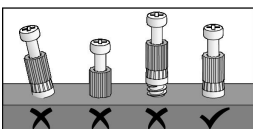

11

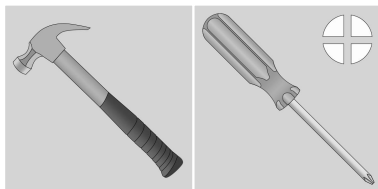

AC000601



2x

AC000103



5x

AC000103

AC000601

PL

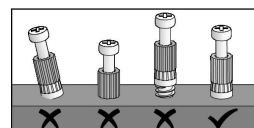

12

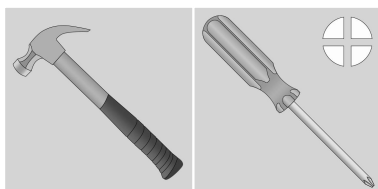

AC000601



2x

AC000103



5x

AC000103

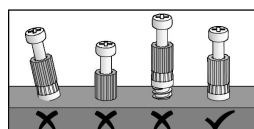

PR

AC000601

13

AC000601



AC000601

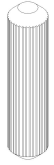

4x

SL



14

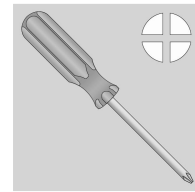

AC000102



10x

PL

E

OB

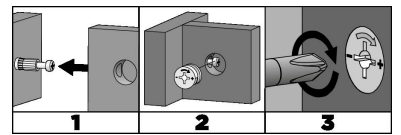

SL

PR

AC000102

E

15

AC000103

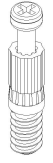
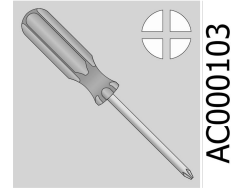

7x

PG

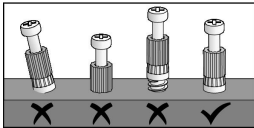

16

PL

AC000102

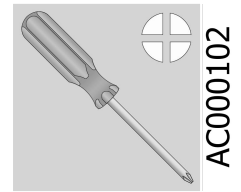

7x

PG

OB

PR

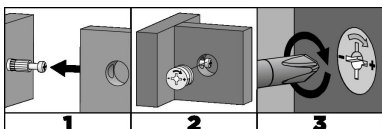

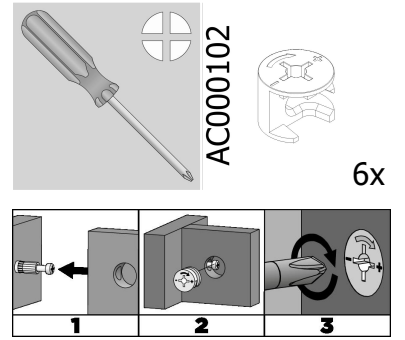

ZL

PL

G

ZR

PR

AC000102

G

18



AC000601

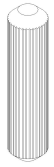

1x

KL

AC000601

19



AC000601

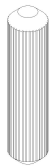

1x

KR

AC000601

20

AC000103

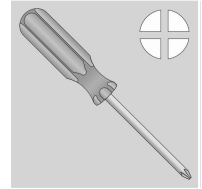

AC000103

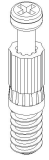

4x

KV

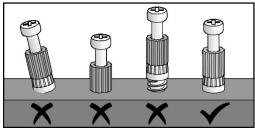

21

KL

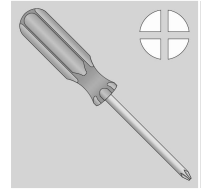

AC000102



4x

KV

AC000102

KR

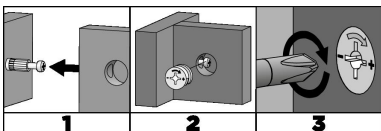

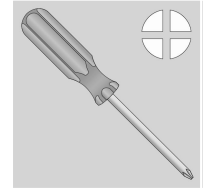

AC000229



7x

H

AC000229

H

BL

KV

ZL

ZR

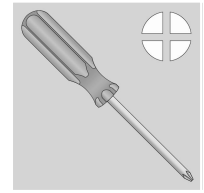

AC000219

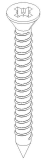

4x

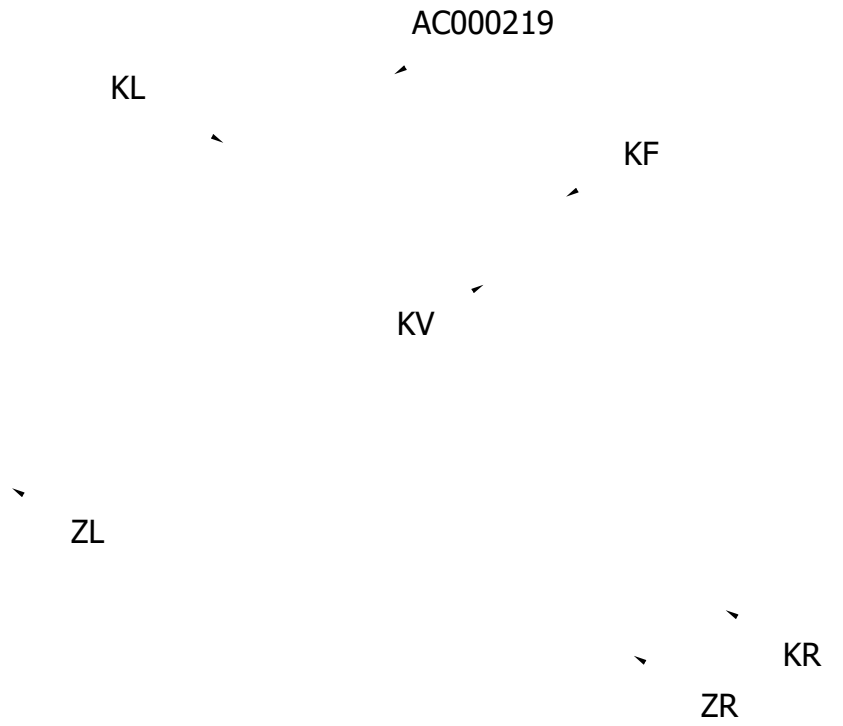



AC000316



50x

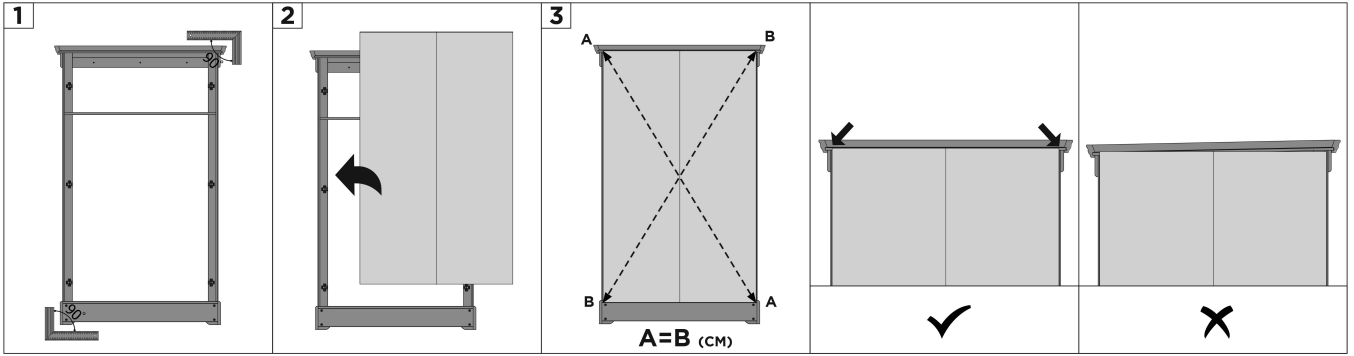

AC000316

AK

KF

ZR

ZL

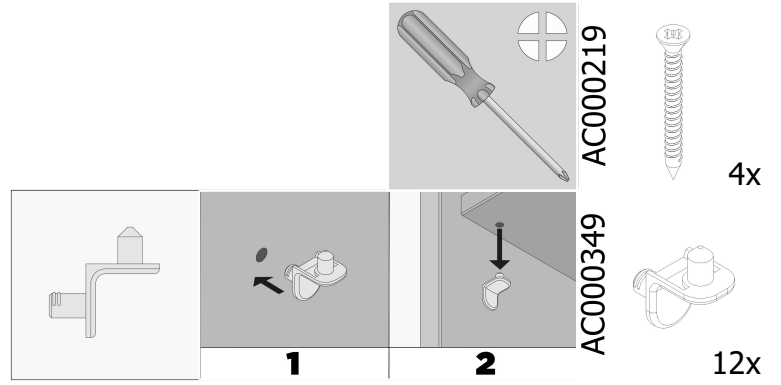

AC000349

J

TP

J

LP

AC000219

LP

K

LP

K OB

DL

26

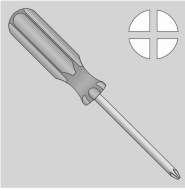

AC000433

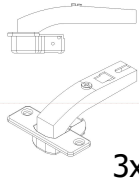

3x

AC000386



1x

AC000383

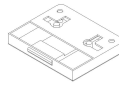

1x

AC000275



4x

AC000204



6x

AC000386

PD-R



AC000204

AC000275

AC000383

AC000433

PD-R

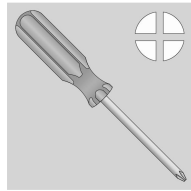

AC000433



3x

AC000514

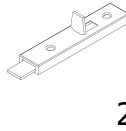

2x

AC000275



4x

AC000204



6x

AC000275

AC000514

L

L

AC000433

AC000204

PD-L

M

AC000275

AC000514

M

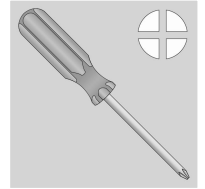

PD-L

PD-R

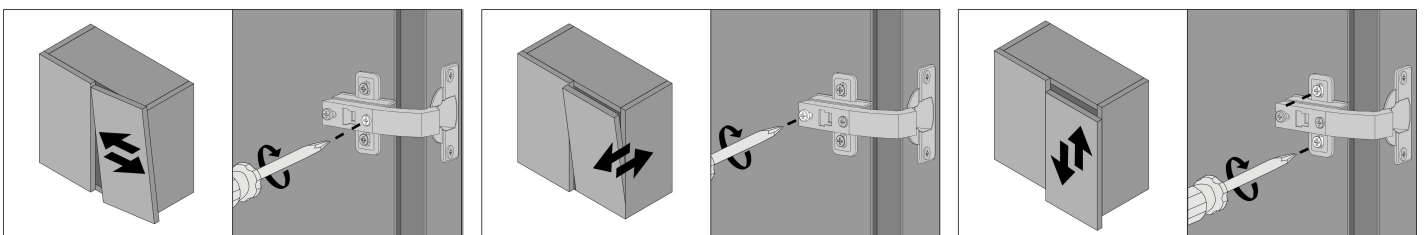

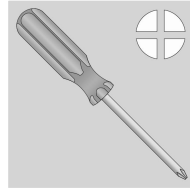

AC000385

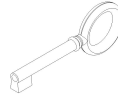

1x

AC000382



1x

AC000275



2x

N

AC000275

AC000382

N

30

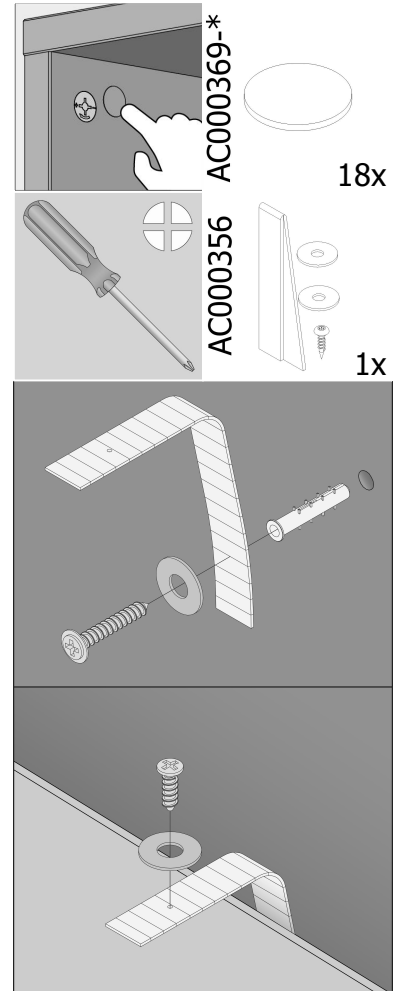
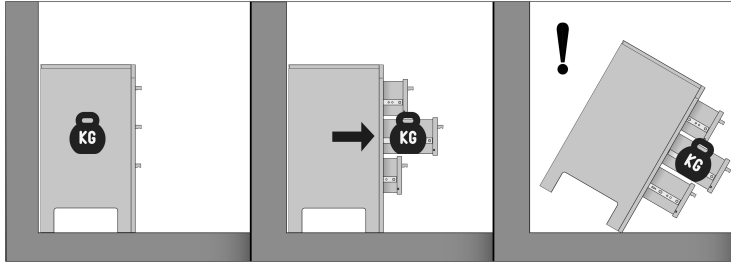

SOCIAL MEDIA

We zijn benieuwd naar het resultaat! Mocht je het met ons willen delen, gebruik #WOOOD op social media.
 We are curious about the result! Would you like to share it with us? Use #WOOOD on social media.
 Wir sind gespannt auf das Ergebnis! Möchten Sie es mit uns teilen? Benutzen Sie #WOOOD in Social Media.
 Nous sommes impatient de connaître le résultat. Souhaitez-vous le partager avec nous? Utilisez #WOOOD sur les médias sociaux.



facebook.com/wood.nl
 instagram.com/madebywood
 pinterest.com/madebywood