

Service

Actona Art.Nr.
15494

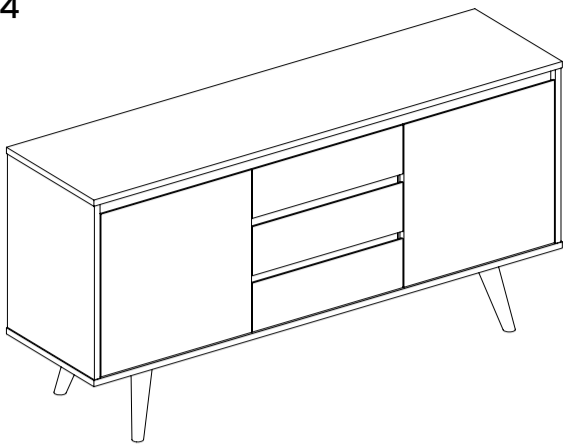

de Für Produktinformationen, Zubehör- und Ersatzteilbestellungen oder Fragen zur Serviceabwicklung wenden Sie sich bitte an unseren Kundenservice. Geben Sie hierfür die Artikelnummer und die Ersatzteil-Bestellnummer an.

**Kundenservice
Deutschland**

☎ **0800 300 01 11**
(kostenfrei)

Montag - Sonntag
(auch an Feiertagen)
von 7.00 bis 22.00 Uhr
E-Mail: service@tchibo.de

Teileliste

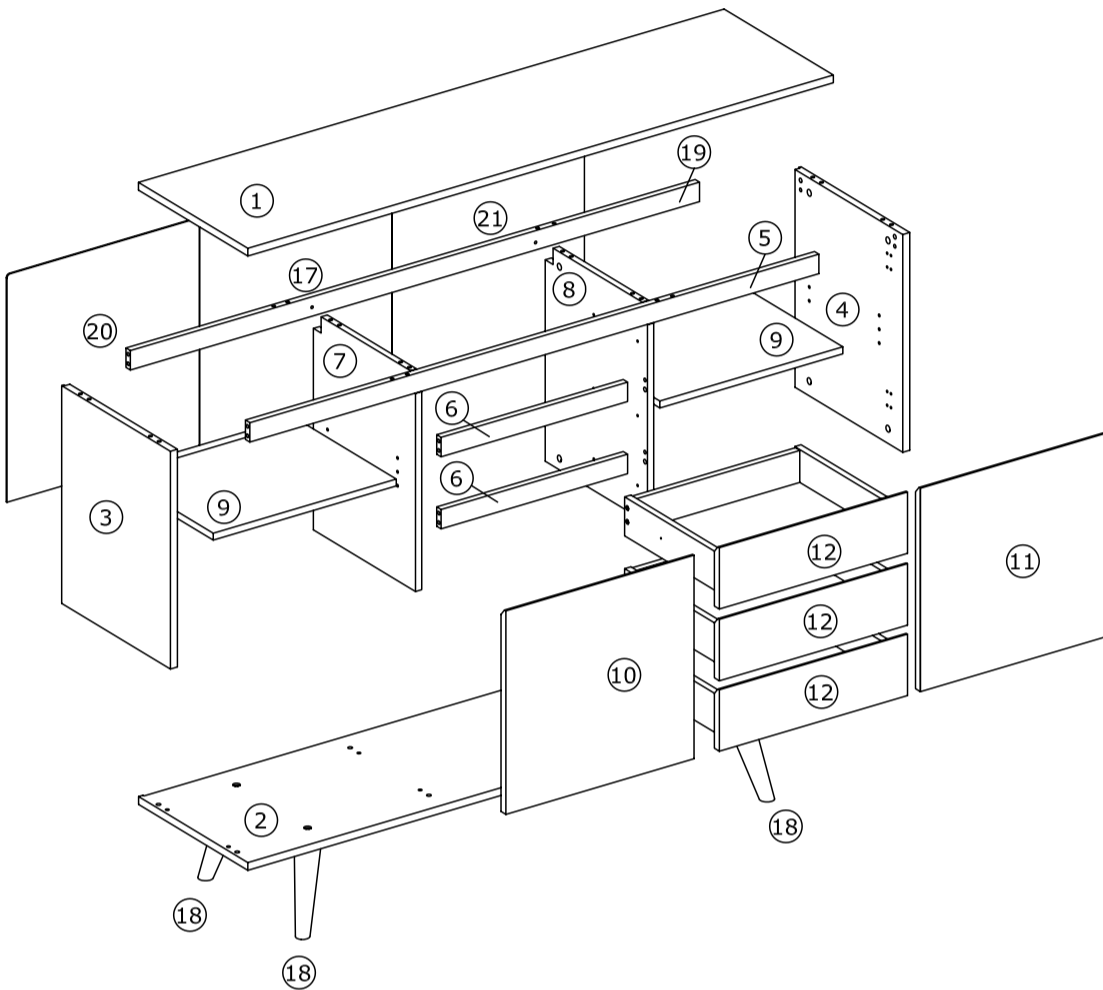



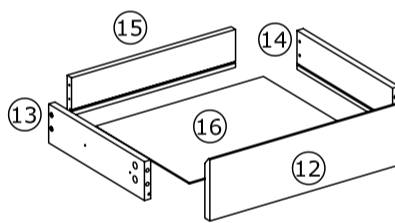





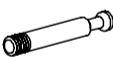









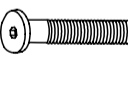
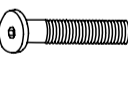



x3

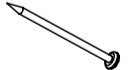

Die folgenden Ersatzteile sind bestellbar

1	5047566
2	5047567
3	5047568
4	5047569
5	5047570
6	5047571
7	5047572
8	5047573
9	5047574
10	5047575
11	5047576
12	5047577
13	5047578
14	5047579
15	5047580
16	5047581
17	5047582
18	5047583
19	5047584
20	5047585
21	5047586

 A x32 ø6.5*43	 B x32 ø15*12	 C x24 ø8*30	 D x6 250mm	 E x6 250mm	 F x12 ø6*8	 G x4
 H x4	 I x44 ø3.5*16	 J x12 ø4*35	 K x4 M6*40	 L x8 M6*50	 M x8 ø10*12	 N x4 M6
 O x4 M6	 P x2 150mm	 Q x2 M4	 R x1 4mm	 S x26 ø1.2*20	 T x8 ø6	 U x2 ø7*40
 V x4 ø25	 W x4 19*14	 X x4 ø3.5*16				

A	5047587
B	5047588
C	5047589
D	5047590
E	5047591
F	5047592
G	5047593
H	5047594
I	5047595
J	5047597
K	5047598
L	5047599
M	5047600
N	5047601
O	5047602
P	5047603
Q	5047604
R	5047605
S	5047606
T	5047607
U	5047608
V	5047609
W	5047610
X	5047611