

# Tchibo

## Electric milk frother



**en** Instructions for use and warranty

Tchibo GmbH D-22290 Hamburg · 107395HB · 2026-06

## Contents

2	About these instructions	8	Problems/solutions
2	Intended use and location	9	Warranty
3	Safety warnings	9	Service and repair
4	At a glance	9	Customer care service
5	Use	9	Product number
7	Safety features		
7	Cleaning		
7	Disposal		
8	Technical specifications		

---

### About these instructions

This product is equipped with safety features. Nevertheless, read the safety warnings carefully and only use the product as described in these instructions to avoid accidental injury or damage.

Keep these instructions for future reference. If you give this product to another person, remember to also include these instructions.

Symbols used in these instructions:



This symbol warns you about the risk of injury.



This symbol warns you about the risk of injury caused by electricity.

Signal words in these instructions:

**DANGER** warns about the imminent risk of serious or fatal injury.

**WARNING** warns about the potential risk of serious or fatal injury.

**CAUTION** warns about the potential risk of minor injury.

**NOTICE** warns about the potential risk of material damage.



This symbol indicates additional information.

---

### Intended use and location

- The milk frother is suitable for warming and frothing milk. Do not put any other liquids or solid foodstuffs into it.
- The milk frother has been designed for household use and use in household-like environments, e.g.
  - shops, offices and similar work spaces,
  - farms,
  - by guests in hotels, motels, bed and breakfasts and other places offering accommodation.
- The product is suitable for use in dry, indoor locations.

## Safety warnings

### **Danger to children and people with limited ability to operate appliances**

- Children must not be allowed to play with the appliance. Keep the appliance and mains cable away from children under the age of 8.
- This appliance may be used by children aged 8+ and by people with diminished physical, sensory or mental capacity or lacking the requisite knowledge/experience, provided they are supervised or have been instructed in the safe use of the appliance and understand the potential dangers.
- Children must not be allowed to clean the appliance unless they are over 8 years of age and supervised while doing so.
- Set up the appliance in a place where children cannot reach it.
- Keep the packaging materials out of the reach of children. They pose several risks, including the risk of suffocation!

### **Danger due to electricity**

- The milk frother is suitable for warming and frothing milk. Use the appliance only for its intended purpose. Use for other purposes can result in injury or material damage.
- The milk frother may only be used with the base supplied.
- The milk frother must never be immersed in water or other liquids. The electric parts must never come into contact with water. Avoid spillages or overflowing around the appliance's plug to ensure that no liquids come into contact with the electric parts.
- The base, plug and mains cable must not come into contact with water or other liquids, as there is otherwise a risk of electric shock. Be careful, therefore, not to place the appliance in the vicinity of a washbasin or sink. Do not use the appliance outside or in rooms exposed to high levels of humidity.
- Never touch the appliance, plug or mains cable with damp hands.

- Connect the appliance to a properly installed, earthed power socket with a mains voltage that complies with the technical specifications of the appliance.
- Never leave the milk frother unsupervised while it is operating.
- Unplug the mains plug from the power socket ...
  - ... if malfunctions occur during use,
  - ... after use,
  - ... during thunderstorms and
  - ... before cleaning the appliance.Always pull on the plug, not on the mains cable.
- The power socket must be easily accessible so that the appliance can be unplugged quickly if necessary.
- The mains cable must not be kinked or crushed. Keep the appliance and mains cable away from hot surfaces and sharp edges.
- The appliance must not be operated using a time switch or a separate remote control system.
- Do not use the appliance if the appliance itself or the mains cable shows visible signs of damage or if the appliance has fallen down.
- Do not make any modifications to the product. If the mains cable is damaged, it must be replaced. Have repairs to the product or the mains cable carried out only by a specialist workshop or as arranged by our customer care service. Improper repairs can result in considerable risks to the user.

### **Warning of burns/scalds**

- The milk frother and its lid in particular become hot during use! Do not touch the hot surfaces. Only touch the milk frother at the bottom and the lid at the edge. Allow both to cool down before cleaning them.
- The heating element inside the milk frother takes longer to cool down than the other parts. Touching it too soon may cause burns!
- Hot milk and steam can cause scalding. Only use the appliance when the lid is firmly placed on the milk frother. Do not reach into or over the appliance when it is in use. Take particular care to avoid any escaping steam when removing the lid.

- Place the appliance on a solid, even surface which can be easily cleaned and is easily accessible. The appliance must not slip around or overturn. Route the mains cable in such a way that it is not a tripping hazard. Do not let the mains cable dangle off the surface, as it may get caught on something and accidentally pull the appliance down.

### Material damage

- Take note of the MIN and MAX markings inside the milk frother. The connector in the bottom of the milk frother must be covered with milk. If there is not enough milk in the milk frother, the appliance can overheat. The milk can froth over if it is overfilled.
- The warming and frothing process must have completed and the milk frother must be switched off before removing it from the base.
- Position the milk frother at a sufficient distance from sources of heat such as ovens or hotplates.
- Do not use any caustic, aggressive or abrasive products for cleaning.
- The milk frother and its accessories are not dishwasher safe. You will find detailed information about cleaning the product in the chapter "Cleaning".
- Only use original accessories.
- It cannot be fully ruled out that some varnishes, synthetic substances and furniture polishes may react adversely with the non-slip material of the feet and soften them. To avoid unwanted marks on furniture, place a non-slip mat underneath the base of the product if necessary.

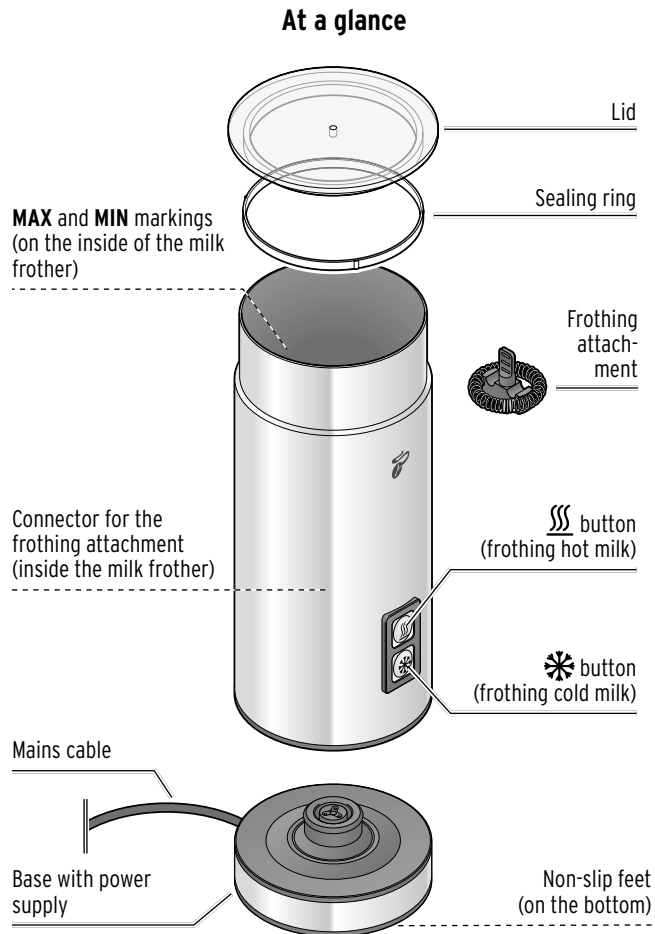

## Use



**DANGER to children** - danger to life by suffocation/choking

Keep the packaging materials out of the reach of children. Dispose of them immediately. Keep small parts out of the reach of children.

1. Remove all packing materials and check that all parts are present.
2. Clean the milk frother, the frothing attachment, the sealing ring and the lid as described in the chapter "Cleaning".

### 1. Setting up the base



**WARNING** - risk of fatal electric shock

Connect the base to a properly installed, earthed power socket with a mains voltage that complies with the technical specifications of the appliance.



**CAUTION** - risk of injury

Place the appliance on a solid, level surface that is easily accessible. The appliance must not slip around and the mains cable should not dangle from the surface on which it is placed.

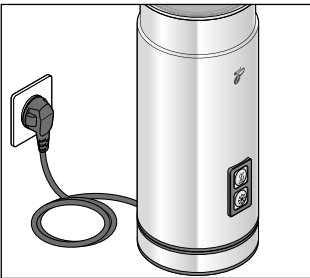

1. Place the base on a firm, level surface.
2. Insert the mains plug into the power socket.

Your appliance is now ready for use.

### 2. Inserting the frothing attachment and pouring in the milk



The amount and quality of the milk froth produced depends on many factors, including the fat content in the milk, whether the milk is fresh or UHT milk, the temperature of the milk or the chosen brand. To keep the milk from frothing over, do not fill the milk frother all the way to the **MAX** mark the first time when trying out a new kind of milk. First test it by using a smaller amount instead. If the milk does froth over, switch off the appliance immediately. Wait for the appliance to cool off somewhat before cleaning it (see the chapter "Cleaning"). We recommend using milk or a milk alternative with a fat content of at least 1.5 %.

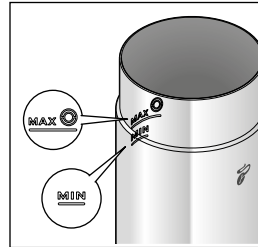

**NOTICE** - material damage

Take note of the **MIN** and **MAX** markings inside the milk frother. The connector inside the milk frother must be covered with milk. If there is not enough milk in the milk frother, the appliance can overheat. The milk can froth over if it is overfilled.

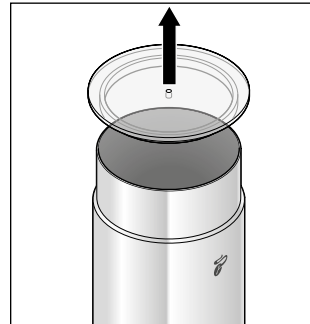

1. Remove the lid from the milk frother.

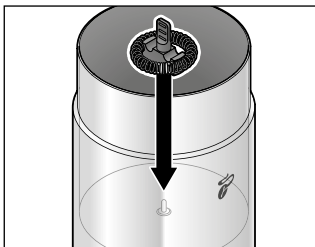

2. Place the frothing attachment onto the connector inside the milk frother as shown (with the handle facing upwards).

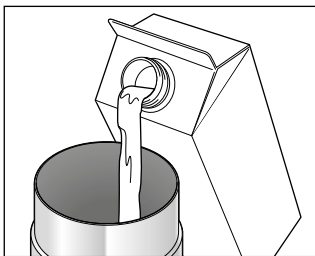

3. Pour milk into the milk frother, taking care not to fill it over the **MAX**  mark.

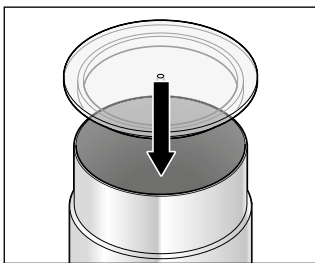

4. Place the lid firmly onto the milk frother.

### 3. Frothing milk



There may be a slight odour when using the appliance for the first time. This is harmless. Make sure there is sufficient ventilation.

### Frothing warm milk

▷ Press the  button briefly.

The  button lights up red. The appliance froths the milk and heats it up at the same time.

The frothing and heating process stops automatically as soon as the target temperature is reached.

You can remove the milk frother from the base.



When the milk is approx. 60-70 °C hot, the frothing and heating process cannot be restarted immediately. The milk and milk frother must first cool down.

### Frothing cold milk



You can also froth milk without heating it.

▷ Press the  button briefly.



The  button lights up blue. The frothing process will stop automatically after approx. 2 minutes.

You can remove the milk frother from the base.

### Interrupting or prematurely ending the frothing process

▷ During the frothing process, briefly press the  button or the  button again.

The corresponding button will go out.

▷ To continue the frothing process, briefly press the  button or the  button again.

### 4. Switching off the appliance

▷ To disconnect the appliance fully from the mains after using it, unplug the mains plug from the power socket.

## Safety features

If the appliance has been switched on without any milk or other contents inside, then, to prevent overheating, it will automatically switch itself off ...  
... after approx. 30-40 seconds if "Frothing warm milk" is selected.  
... after approx. 120 seconds if "Frothing cold milk" is selected.

## Cleaning



**WARNING** - risk of fatal electric shock

- Always remove the mains plug from the power socket before cleaning the appliance.
- The base, plug and mains cable must not be exposed to moisture. Be sure also to protect these parts against drops and splashes of water.
- The milk frother must never be immersed in water or other liquids. The electric parts must never come into contact with water.

**NOTICE** - material damage

Do not use any caustic, aggressive or abrasive products for cleaning.



Always clean the milk frother after every time you froth milk in it. This prevents the milk from drying and hardening inside it.

1. Disconnect the mains plug from the power socket and leave the appliance to cool down sufficiently.
2. Take the sealing ring off the lid and remove the frothing attachment from the connector in the milk frother.
3. Clean the lid, sealing ring and frothing attachment you have used in warm water with a little washing-up liquid.

4. Clean only the inside of the milk frother with warm water and washing-up liquid.
5. Wipe off the base with a soft, slightly dampened cloth as necessary.
6. Carefully dry all the parts afterwards, especially the milk frother, to avoid stains.
7. Insert the sealing ring back into the groove in the lid correctly.

## Disposal

This product and its packaging have been manufactured from valuable materials that can be recycled. Recycling reduces the amount of refuse and preserves the environment.

Dispose of the **packaging** at a recycling point which sorts materials by type. Make use of the local facilities provided for collecting paper, cardboard and lightweight packaging.



**Appliances** marked with this symbol must not be disposed of along with normal household waste!

You are legally obliged to dispose of old appliances separately from household waste. Electronic appliances contain hazardous substances and, if stored or disposed of improperly, may cause harm to health or the environment. Information about collection points where old appliances can be disposed of free of charge is available from your local authorities.

## Technical specifications

Model:	394 101
Mains voltage:	220-240 V ~ 50 Hz
Protection class:	I 
Power:	450-550 W
Automatic switch-off:	after approx. 1 minute (after frothing warm milk) after approx. 2 minutes (after frothing cold milk)
Power consumption when switched off:	0.3 W
Capacity:	approx. 130 ml
Made exclusively for:	Tchibo GmbH, Überseering 18, 22297 Hamburg, Germany

In the course of product improvement, we reserve the right to make technical and optical modifications to the product.



## Problems/solutions

### Not working.

- Is the appliance plugged in?
- Is the milk frother fitted correctly onto the base?

### The milk warms up, but does not froth.

- Has the frothing attachment been properly fitted onto the connector in the milk frother?

### The milk warms up, but does not froth enough.

- Is there any residue on the frothing attachment or inside the milk frother?

### The appliance is unusually loud.

- Is there enough milk in it?
- Has the frothing attachment been properly fitted onto the connector?
- Has the lid been firmly fitted onto the milk frother?

## Warranty

Tchibo GmbH grants a **two-year warranty** from the date of purchase.

Tchibo GmbH, Überseering 18, 22297 Hamburg, Germany

We will remedy all defects in workmanship or materials **within the warranty period**. In order for the warranty to be granted, all warranty claims must be accompanied by proof of purchase from Tchibo or from an authorised Tchibo distribution partner. This warranty is valid within the EU, Switzerland and Turkey.

**The warranty does not cover** worn parts, consumables, or damage resulting from improper use or inadequate descaling. Parts and consumables can be ordered from our customer care service.

This warranty does not restrict **statutory warranty rights**. Statutory warranty rights can be asserted free of charge.

## Service and repair

If, contrary to our expectations, a defect is found, please contact our customer care service. Our customer consultants will be happy to advise you on further procedure.

If you have any questions relating to product information, ordering accessories or servicing, please contact our customer care service. Please have the product number to hand in case of any queries.

---

## Customer care service

Email: [service@tchibo.de](mailto:service@tchibo.de)

---

## Product number



Product number

You can find the product number of your appliance on the type plate on the bottom of the casing.