

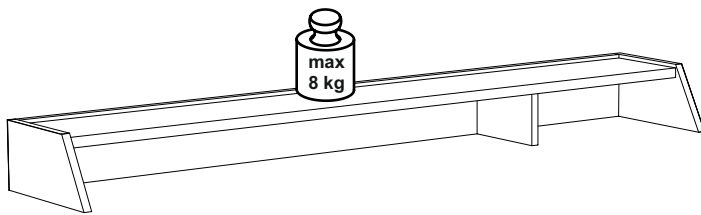

- | | | |
|---|--|--|
| (D) Videounterstützte Montageanleitung | (GB) Video-assisted assembly instructions | (FR) Instructions de montage assistées par vidéo |
| (TR) Video destekli kurulum talimatları | (IT) Istruzioni di montaggio video-assistite | (NL) Video-ondersteunde montage-instructies |
| (RU) инструкция по монтажу с помощью видеосигнала | (CZ) Instalační pokyny podporované videem | (HU) Video-támogatott telepítési utasítások |
| (RO) Instrucțiuni de instalare acceptate video | (PL) Instrukcje montażu wspomagane sygnałem wizyjnym | (SK) Inštaláčne pokyny podporované videom |

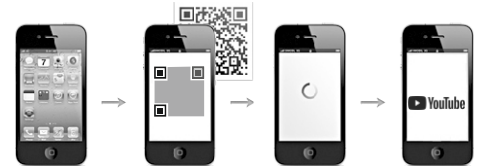

Art.-Nr.: **0215_SA**

REPC-Nr.:

Schreibtischaufsatz



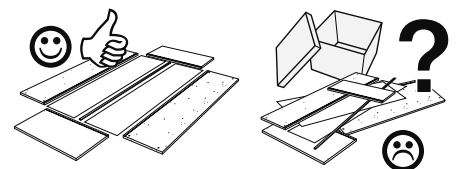
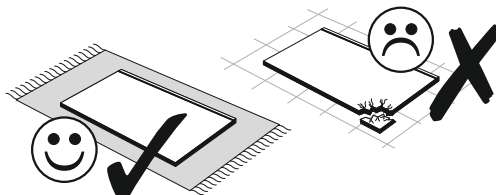
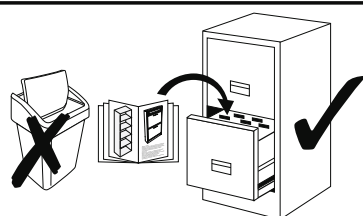
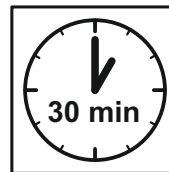
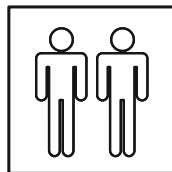
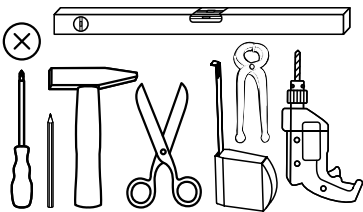



Service • Assistenza • Dienstverlening • Serwis
Servis • Szerviz • Сервисная служба

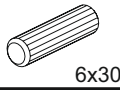

SCAN ME

Das Ersatzteil-Anforderungsformular finden Sie auf
The replacement parts requisition form you find on
<https://www.maeusbacher.de/ersatzteile/>

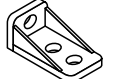
BT1-00275 Colli 1/1

B02-90 2x	 6x30	B02-10 8x		B02-20 8x		
B05-130 1x		B03-134 6x		B02-133 1x		B01-122 2x
						 4x13



▶ SCAN ME

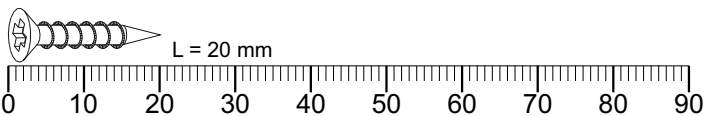

Colli 1/1



1340 x 174 1x

(FTx-000597)



172 x 98 1x

(FTx-000600)



1340 x 124 1x

(FTx-000601)



260 x 124 1x



(FTx-000599)

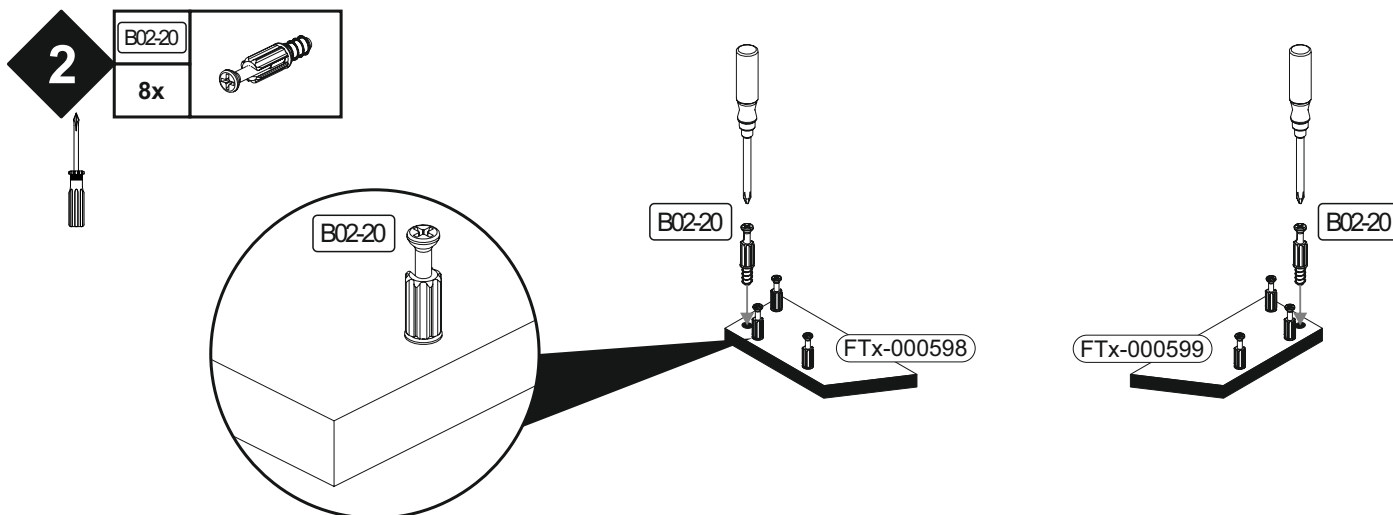
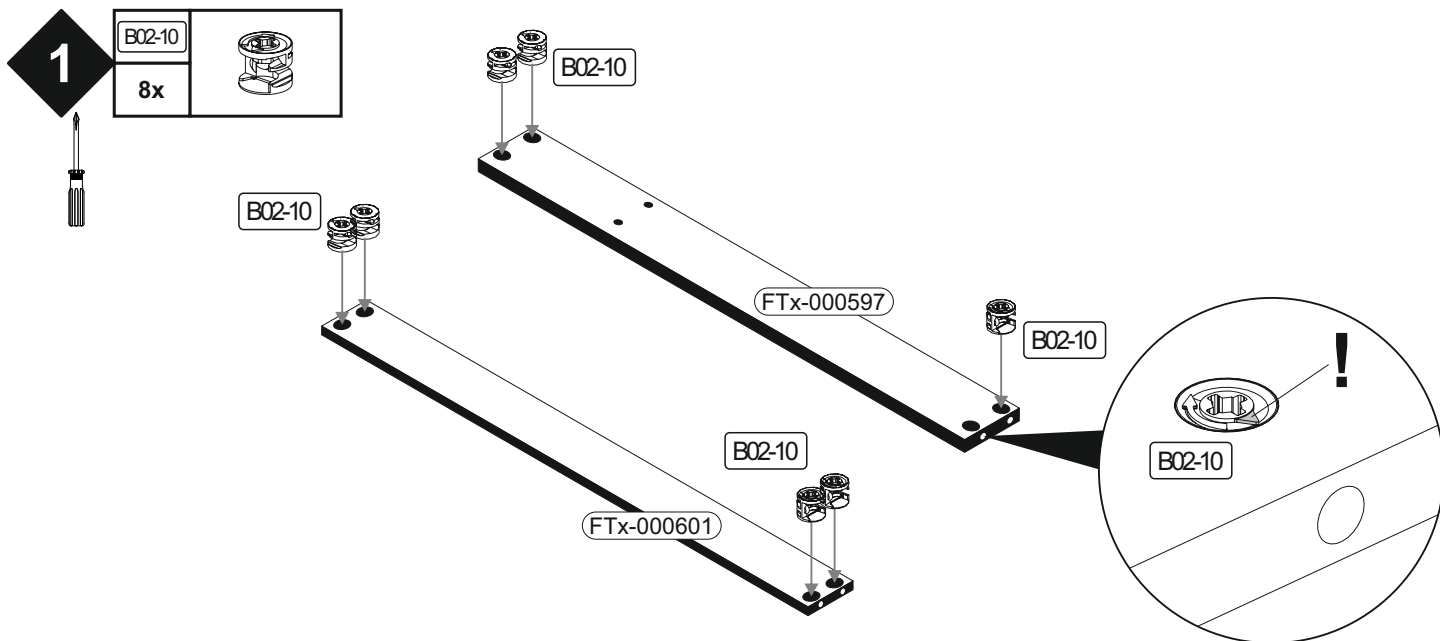

260 x 124 1x

(FTx-000598)

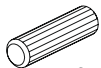

3	B02-90	
	2x	6x30
	B05-130	
	1x	

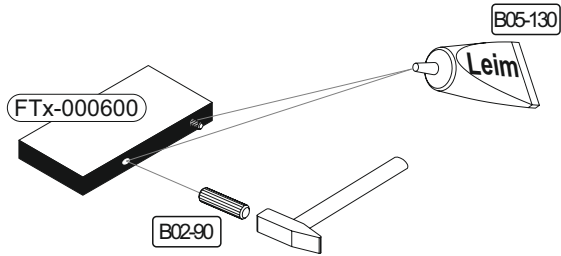
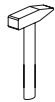

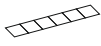
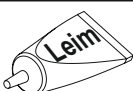
4	B03-134	
	2x	
	B05-130	
	1x	

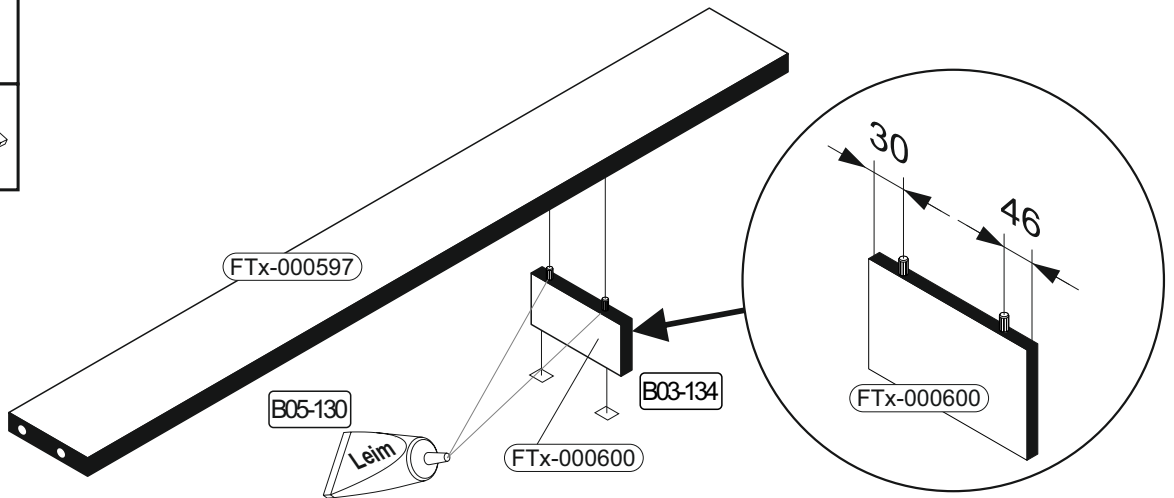

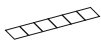
5	B03-134	
	4x	

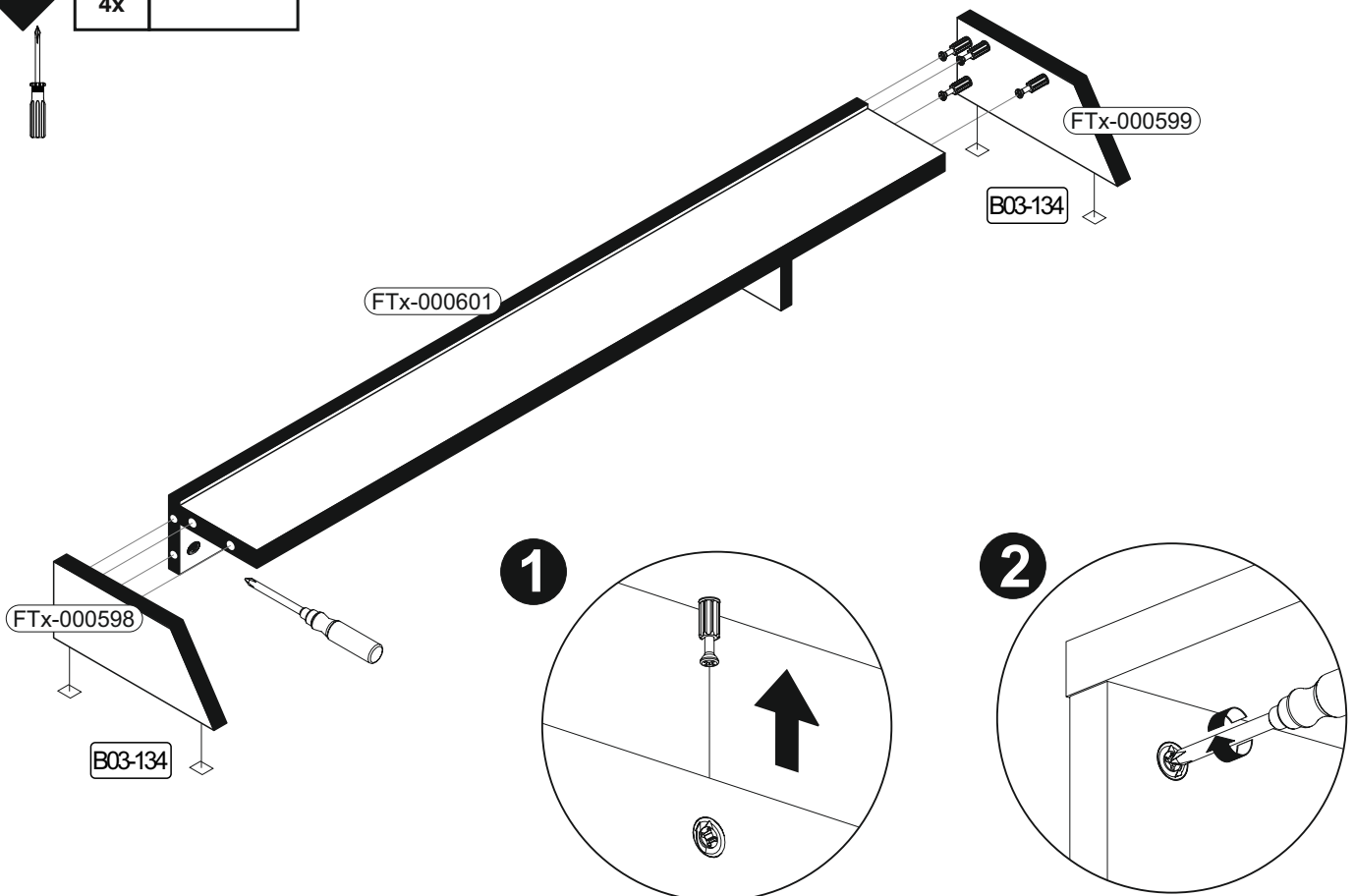

6



B02-133		B01-122	
1x		2x	4x13

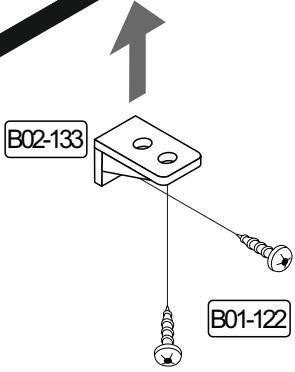
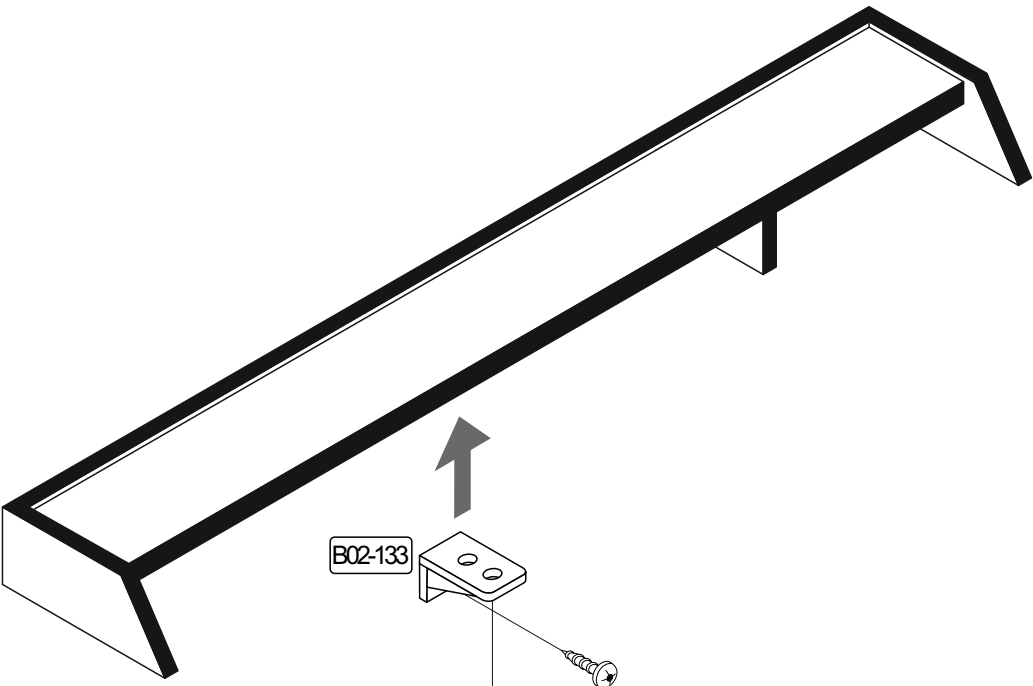



(D) Videounterstützte Montageanleitung

(TR) Video destekli kurulum talimatları

(RU) инструкция по монтажу с помощью видеосигнала

(RO) Instrucțiuni de instalare acceptate video

(GB) Video-assisted assembly instructions

(IT) Istruzioni di montaggio video-assistite

(CZ) Instalační pokyny podporované videem

(PL) Instrukcje montażu wspomagane sygnałem wizyjnym

(FR) Instructions de montage assistées par vidéo

(NL) Video-ondersteunde montage-instructies

(HU) Video-támogatott telepítési utasítások

(SK) Inštalčné pokyny podporované videom

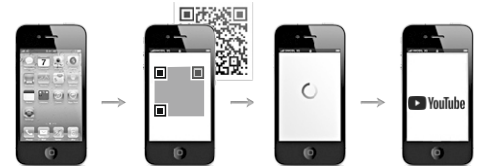
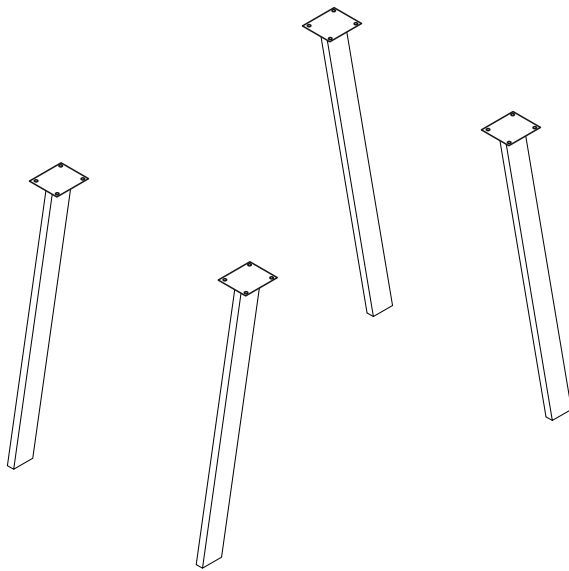

Art.-Nr.: **0212_Eckig-72 P2**
Tischbeinset

REPC-Nr.:

Service • Assistenza • Dienstverlening • Serwis
Servis • Szerviz • Сервисная служба

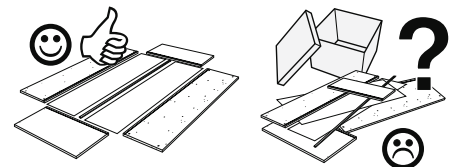
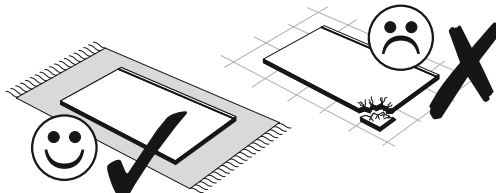
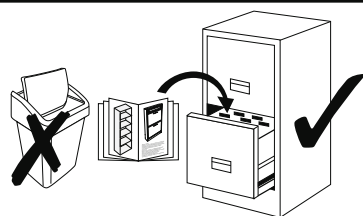
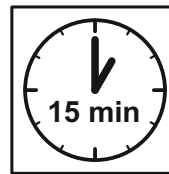
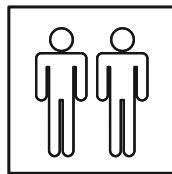
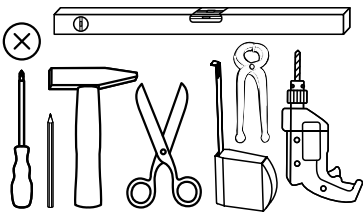

SCAN ME

Das Ersatzteil-Anforderungsformular finden Sie auf
The replacement parts requisition form you find on
<https://www.maeusbacher.de/ersatzteile/>

Beutel 1/1

4,5x20	
16x	4,5x20

Colli 1/1

